

Draft
NEW YORK STATE RELIABILITY COUNCIL, L.L.C.
(“NYSRC”)
POLICY NO. 5-78

**PROCEDURE FOR ESTABLISHING
NEW YORK CONTROL AREA
INSTALLED CAPACITY REQUIREMENTS**

Approved by NYSRC Executive Committee: April July 11, 2013-2014
Date Issued: April 12, 2013 July 11, 2014

Style Definition: NYSRC Heading 3

Style Definition: TOC 1

Style Definition: TOC 2

Style Definition: TOC 3

Style Definition: TOC 4

Style Definition: TOC 5

Formatted Table

5.2 EXECUTIVE COMMITTEE IRM VOTING PROCEDURE.....22

Field Code Changed

Formatted: Font: +Body (Calibri), 11 pt

APPENDICES

- APPENDIX A Unified Methodology Description
- APPENDIX B Selection of Tan 45 Points on IRM/LCR Curves Established by the Unified Methodology
- APPENDIX C Retirement Guidelines
- APPENDIX D Procedure for Aligning the Base Case to the Final IRM in Preparation for the Locational Capacity Requirement Study by the NYISO
- APPENDIX E Development of Generator Transition Rate Matrices for MARS that are Consistent with the EFORd Reliability Index

Formatted: Font: Not Bold



Section 1: Introduction

The reliable supply of electric services within the New York Control Area (NYCA) depends on adequate and dependable generation and transmission facilities. This policy focuses on the supply of electricity; specifically, the process that will be followed by the New York State Reliability Council (NYSRC) for determining and setting the amount of resource capacity required to ensure an acceptable level of service reliability in the NYCA.

The general requirements and obligations concerning NYCA resource adequacy and Installed Capacity Requirements (ICR) are defined in the New York State Reliability Council (NYSRC) Agreement and the New York Independent System Operator (NYISO)/NYSRC Agreement. Under these Agreements the NYSRC is responsible for calculating and establishing the amount of resource ICR to meet NYSRC Reliability Rules. In compliance with this obligation, the NYSRC Executive Committee approves an NYCA required Installed Reserve Margin (IRM) requirement for the following May through April capability year. The ICR relates to the IRM through the following equation:

$$\text{ICR} = (1 + \text{IRM}\%/100) \times \text{Forecasted NYCA Peak Load}$$

The final NYCA IRM requirement, as approved by the NYSRC Executive Committee, is the basis for various installed capacity analyses conducted by the NYISO. These NYISO analyses include the determination of the capacity obligation of each Load Serving Entity (LSE) on a Transmission District basis, as well as Locational Installed Capacity Requirements, for the following capability year. These NYISO analyses are conducted in accordance with NYSRC Reliability Rules and Procedures.

Section 2: Overview of the Reliability Calculation Process

This section provides an overview of the NYSRC reliability calculation process, including the major modeling parameters for establishing statewide IRM requirements, a timeline for this process, and reporting requirements for the technical IRM study (IRM Study).

2.1 Calculation Process

The reliability calculation process for determining the NYCA IRM requirement utilizes a probabilistic approach. This technique calculates the probabilities of outages of generating units, in conjunction with load and transmission models, to determine the number of days per year of expected capacity shortages. The General Electric Multi-Area Reliability Simulation (MARS) is the primary computer program used for this probabilistic analysis. The result of the calculation is termed Loss of Load Expectation (LOLE), which provides a consistent measure of system reliability. The relationship between MARS and the various models used in the NYCA IRM calculation process is depicted in Figure 2-1. The Installed Capacity Subcommittee (ICS) of the NYSRC has the responsibility of monitoring these studies and preparing reports for establishing NYCA ICR.

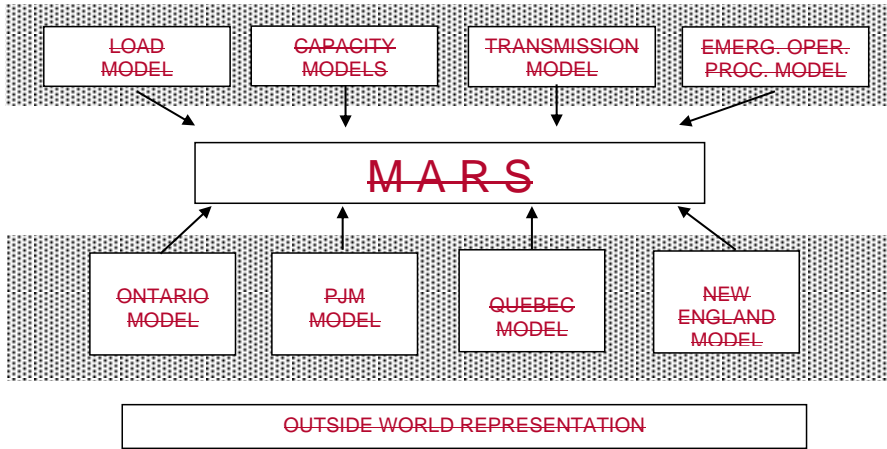

Figure 2-1: Relationship between MARS and the Models Used In the IRM Requirement Calculation Process

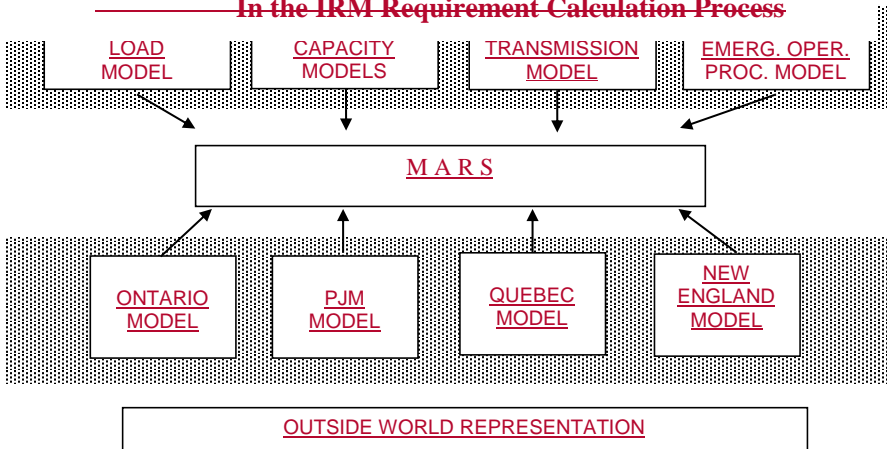

Figure 2-1: Relationship between MARS and the Models Used In the IRM Requirement Calculation Process

2.2 Timeline

A timeline for establishing NYCA IRM requirements is shown in Table 2-1 [top of the next page](#). This timeline is based on adopting an IRM in early December in order to provide the NYISO with next year's NYCA IRM requirement in sufficient time to recognize the NYISO's need to complete

its installed capacity and procurement process and begin its studies for determining the following summer's LSE capacity obligations.

Adherence to this schedule is necessary to support the NYSRC annual filing with FERC to advise FERC of the annual state-wide IRM requirement for the New York Control Area for the following capability year if needed to seek FERC approval of any revision to the IRM requirement, and to notify the NYISO so that its capacity commitment schedule can be met.

Table 2-1:
Timeline for the Establishment
Of the
NYCA Installed Capacity Requirements
Establishment Timeline

Monthly Meeting	Event/Deadline	Section References
February	➤ Begin development of IRM study base case assumptions matrix, including input data and modeling enhancements (ICS/NYISO).	3.5
	➤ Identify potential major modeling enhancements and begin preparation of white papers (ICS/NYISO).	3.5
March	➤ Begin preparation of transmission topology (NYISO).	3.5.4
May	➤ Complete development of new major models and approve related white papers (NYISO/ICS).	3.5
June	➤ Benchmark new MARS version received from GE (NYISO).	3.2
	➤ NYISO completes transmission topology and delivers to ICS.	3.5.4
	➤ From modeling enhancement white papers, identify which will be used for this year's IRM study and which that need an additional year before implementation (ICS).	3.5
July	➤ New model representations received from Outside Areas (NYISO).	3.5.6
	➤ If applicable, approve use of new MARS version for this year's study (ICS).	3.2
	➤ Complete calculation of IRM impacts of major modeling enhancements (NYISO).	3.5
	➤ Approve transmission topology (ICS).	3.5.4
	➤ Begin data quality assurance reviews (NYISO/GE/TOs).	3.8

- Formatted: Font: 12 pt, Not Bold
- Formatted: Tab stops: Not at 1.25"
- Formatted: Font: 12 pt, Not Bold
- Formatted: Justified, Indent: Left: 0", Tab stops: Not at 1.25"
- Formatted Table

	➤ Approve preliminary base case assumptions matrix, including new major models (ICS/Executive Committee [EC]).	3.5
August	➤ Complete parametric studies (NYISO). ➤ Begin preliminary base case study (NYISO). ➤ Approve list of sensitivity cases (ICS/EC)	3.4 3.4 3.6
September	➤ Approve preliminary base case study (ICS). ➤ Begin sensitivity testing (NYISO).	3.4 3.6
October	➤ Fall NYCA load forecast delivered to ICS from NYISO ➤ Base Case assumptions lock-down (ICS) ➤ Approve Final base case assumptions matrix (ICS/EC) ➤ Begin preparation of base case study (NYISO). ➤ Begin preparation of draft IRM report (ICS). ➤ Complete data quality assurance reviews (NYISO/GE/TOs). ➤ Review sensitivity results (ICS).	3.5.1 3.6 3.5 3.4 2.3 3.8 3.6
November	➤ Complete Draft IRM study report (ICS). ➤ Approve Base case IRM (ICS/EC). ➤ If required prepare Special Sensitivity Case(includes all assumption changes after assumption lock-down)(ICS/NYISO)	2.3 3.4 3.6
December	➤ Complete Final IRM study report (ICS). ➤ Approve sensitivity results,(ICS/EC).Approve Final IRM Study (EC). ➤ Final IRM adopted (EC)	2.3 3.6 3.4 5.0
Mid-December	➤ Issue letter to the NYISO CEO, press release, and IRM filing to FERC (if needed) announcing final IRM (EC) ➤ Complete base case alignment study (ICS)	4.4 3.5.5

~~Adherence to this schedule is necessary to support the NYSRC annual filing with FERC to advise FERC of the annual state wide IRM requirement for the New York Control Area for the following capability year if needed to seek FERC approval of any revision to the IRM requirement, and to notify the NYISO so that its capacity commitment schedule can be met.~~

2.3 IRM Study Reporting Requirements

In accordance with the NYSRC Reliability Rules, the NYSRC prepares the IRM Study, a technical report providing the assumptions, procedures, and results of analyses for determining NYCA IRM requirements. Drafts of this report are posted on the NYSRC web site and comments from all market participants are solicited during the NYCA IRM determination process in accordance with NYSRC Openness Policy 2.

Section 3: Reliability Calculation

This section contains the criterion used for calculating the required NYCA IRM level, a description of the reliability calculation, including the primary computer program used, and a description of the input data and models used in the reliability calculation. Section 5 will cover the process for

establishing the final IRM requirement for the following capability year, which evaluates the base case and sensitivity case results determined by the reliability calculation described in Section 3.

3.1 NYSRC Resource Adequacy Criterion

The acceptable LOLE reliability level in the NYCA is stated in the NYSRC Reliability Rules. NYSRC Reliability Rule A-R1, *Statewide Installed Reserve Margin Requirements*, states:

The NYSRC shall establish the IRM requirement for the NYCA such that the probability (or risk) of disconnecting any firm load due to resource deficiencies shall be, on average, not more than once in ten years. Compliance with this criterion shall be evaluated probabilistically, such that the loss of load expectation (LOLE) of disconnecting firm load due to resource deficiencies shall be, on average, no more than 0.1 day per year. This evaluation shall make due allowance for demand uncertainty, scheduled outages and deratings, forced outages and deratings, assistance over interconnections with neighboring control areas, NYS Transmission System transfer capability, and capacity and/or load relief from available operating procedures.

This Rule is consistent with the NPCC Resource Adequacy Criterion and may be modified from time to time, as appropriate, in accordance with the NYSRC open process procedure for modifying NYSRC Reliability Rules (NYSRC Policy 1). The NYS Transmission System transfer capability in the above Reliability Rule is represented using emergency transfer limits.

3.2 Computer Program Used for Reliability Calculation

The primary tool used in the probabilistic analysis for establishing NYCA IRM requirements is a General Electric computer program called the Multi-Area Reliability Simulation (MARS). This program includes a detailed load, generation, and transmission representation for 11 NYCA zones (A through K), as well as the four external Control Areas (Outside World Areas) interconnected to the NYCA (see Section 3.3 for a description of these zones and Outside World Areas).

A sequential Monte Carlo simulation forms the basis for MARS. The Monte Carlo method provides a fast, versatile, and easily expandable program that can be used to fully model many different types of generation and demand-side options.

The MARS program calculates the standard reliability indices of daily and hourly LOLE (days/year and hours/year) and Loss of Energy Expectation (LOEE in MWh/year). The use of sequential Monte Carlo simulation allows for the calculation of time-correlated measures such as frequency (outages/year) and duration (hours/outage). The program also calculates the need for initiating Emergency Operating Procedures (EOPs), expressed in days/year (see Section 3.5.3).

In addition to calculating the expected values for the reliability indices, MARS also produces probability distributions that show the actual yearly variations in reliability that the NYCA could be expected to experience.

In determining the reliability of the NYCA there are several types of randomly occurring events that must be taken into consideration. Among these are the forced outages of generating units and

transmission capacity. Monte Carlo simulation models the effects of such random events. Deviations from the forecasted loads are captured by the use of a load forecast uncertainty model.

Monte Carlo simulation approaches can be categorized as “non-sequential” and “sequential”. A non-sequential simulation process does not move through time chronologically or sequentially, but rather considers each hour to be independent of every other hour. Because of this, non-sequential simulation cannot accurately model issues that involve time correlations, such as maintenance outages, and cannot be used to calculate time-related indices such as frequency and duration.

A sequential Monte Carlo simulation, the approach used by the MARS program, steps through the year chronologically, recognizing the fact that the status of a piece of equipment is not independent of its status in adjacent hours. Equipment forced outages are modeled by taking the equipment out of service for contiguous hours, with the length of the outage period being determined from the equipment’s mean time to repair. The sequential simulation can model issues of concern that involve time correlations, and can be used to calculate indices such as frequency and duration. It also models transfer limitations between individual areas.

Because the MARS Program is based on a sequential Monte Carlo simulation, it uses state transition rates, rather than state probabilities, to describe the random forced outages of the thermal units. State probabilities give the probability of a unit being in a given capacity state at any particular time, and can be used if one assumes that the unit’s capacity state for a given hour is independent of its state at any other hour. Sequential Monte Carlo simulation recognizes the fact that a unit’s capacity state in a given hours is dependent on a given state in previous hours and influences its state in future hours. It thus requires additional information that is contained in the transition rate data.

If an updated MARS software version becomes available by June 1, prior to the conduct of IRM study cases, ICS should consider its use for conducting the study. The decision to select a new MARS version depends on desirable improvements in the reliability calculation process or correction of program errors in the new version. If there is a decision to utilize a new MARS version, it must be tested and benchmarked by the NYISO to ensure that it produces acceptable results. Such tests normally compare results for reasonableness with study results from a previous MARS version using the same assumptions. If a new MARS version becomes available after commencement of IRM study cases, it may be considered for use for the following IRM study.

3.3 NYCA Zones and Outside World Representation

Figure 3-1 depicts the NYCA Zones and Outside World Areas represented in MARS.

Formatted: Left

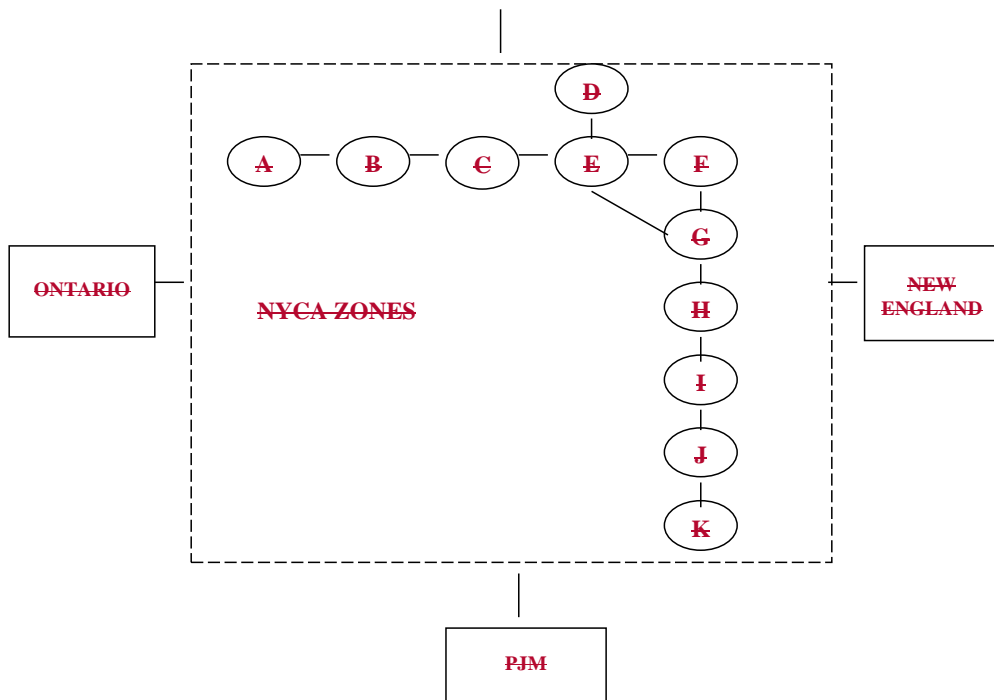
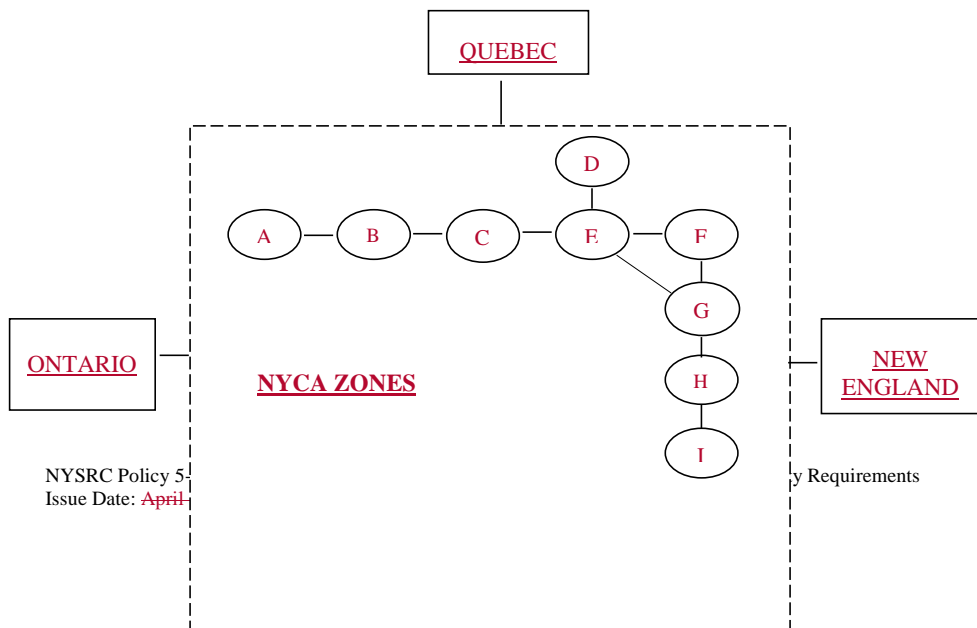
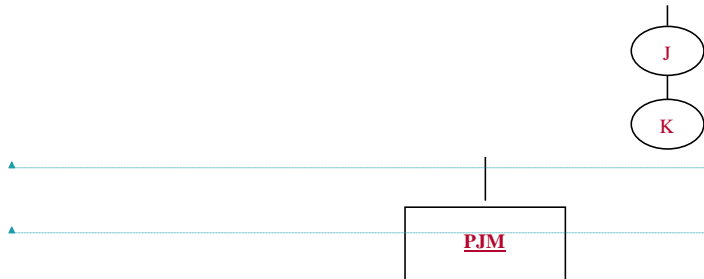

Figure 3-1: Simplified MARS Representation of NYCA Zones & Outside World Areas





Formatted: Font: 14 pt, Italic

Formatted: Font: 14 pt, Italic

Formatted: Font: 14 pt, Italic

Figure 3-1: Simplified MARS Representation of NYCA Zones & Outside World Areas

3.4 Conduct of the MARS Analysis

Formatted: Font: 14 pt, Not Italic, No underline

Each year’s MARS IRM analysis develops both a *preliminary base case* and a *final base case*.

The Preliminary Base Case

The preliminary base case is developed by starting with the previous year’s final base case and inputting base case changes one parameter at a time. The LOLE results of each of these pre-base case simulations are reviewed to confirm that the reliability impact of the change is reasonable and explainable. This base case incorporates a preliminary peak load forecast (see Section 3.5.1). The preliminary base case is used to conduct sensitivity studies (see Section 3.6).

The Final Base Case

The final base case is prepared following receipt of the NYISO’s Fallfall load forecast (see Section 3.5.1). The final base case may also include data changes resulting from quality assurance reviews. The final base case is used to calculate the final IRM. The final base case includes updates or corrections, approved by ICS, which have occurred since the preliminary base case.

3.4.1 Unified Method for Establishing IRM Requirements

The procedure utilized for establishing NYCA IRM requirements is termed the *Unified Method* because it provides a coordinated approach that ~~is~~ can also be used by the NYISO for its analysis



of Locational Capacity Requirements (LCRs).¹ The Unified Method establishes/reflects a graphical relationship between NYCA IRM and the LCRs as depicted graphically in Figure 3-2.

Under this method capacity is removed from zones west of the Central-East interface that have excess capacity when compared to their forecast peaks until a study point IRM is reached. At this point, capacity is shifted from Zones J and K into the same zones as above until the 0.1 LOLE criterion is violated. Doing this at various IRM points yields a curve such as depicted in Figure 3-2, whereby all points on the curve meet the NYSRC 0.1 days/year LOLE criterion. Furthermore, all LCR “point pairs” for NYC and LI curves along the IRM axis represent a 0.1 LOLE solution for NYCA. Appendix A provides a detailed description of the Unified Method.

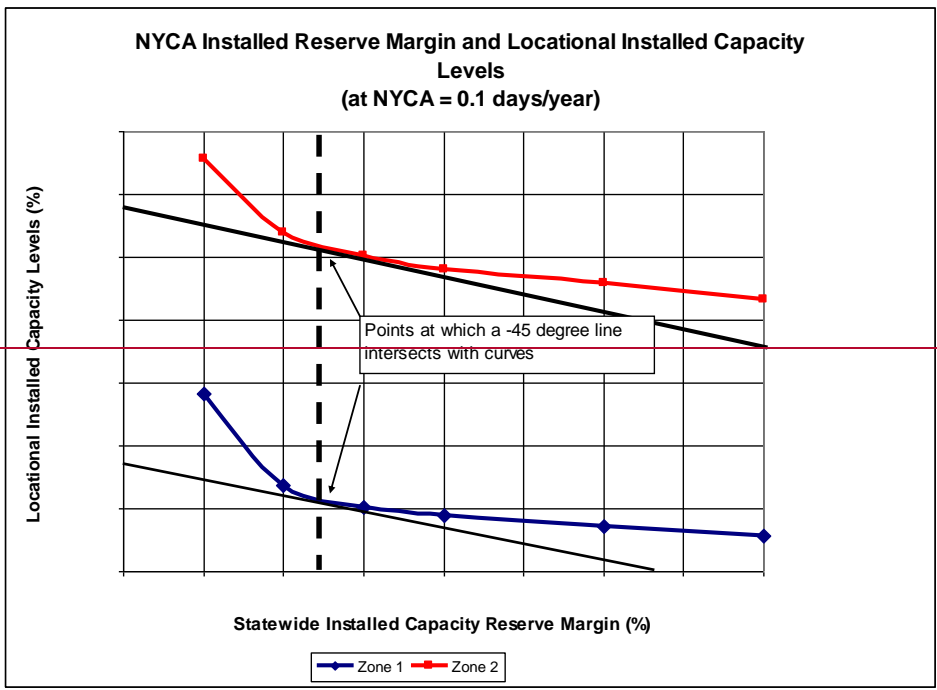

¹ NYSRC Policy 5 does not determine the method by which the LCRs are set. Rather, the NYISO determines LCRs for all Localities through its tariff and procedures.

5

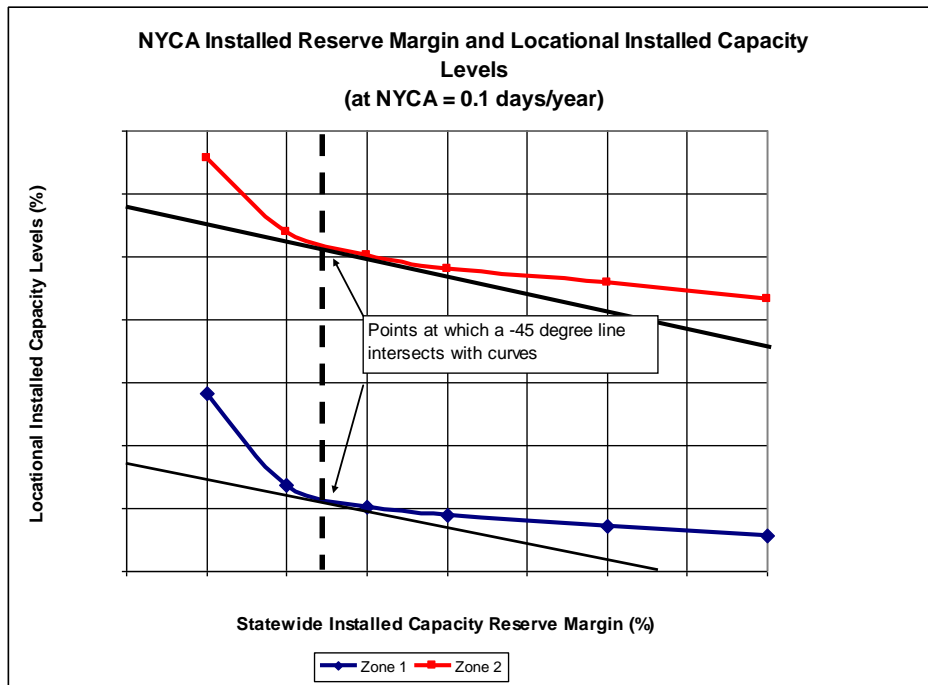

Figure 3-2: Unified Curve and IRM Anchor Point

3.4.2 Base Case IRM Anchoring Methodology

This method establishes base case NYCA IRM requirements and related minimum LCRs from IRM/LCR curves established by the Unified Method described in Section 3.4.1. The *anchor point* on the curve in Figure 3-2 is selected by applying a tangent of 45 degrees (“Tan 45”) analysis at the bend (or “knee”) of the curve. Points on the curve on either side of the Tan 45 point may create disproportionate changes in LCR and IRM, since small changes in LCR can introduce larger changes in IRM Requirements and vice versa. Appendix B describes the mathematical analysis for selecting Tan 45 points on the curves. Alternative anchoring methods will be periodically evaluated.

3.5 Input Data and Models

This section describes the load, capacity, and transmission models that are input to the MARS program for determining NYCA IRM requirements.

The input data and models used for an IRM study’s base case are incorporated into an *Assumptions Matrix* which is prepared early in the study process (see Table 2-1) as this information becomes available. A proposed major enhancement of a model is given a thorough review – requiring testing

and preparation of a white paper – before it is accepted for use in the base case. If it is found that a proposed model enhancement cannot be developed in time for the next IRM study, its implementation may be delayed to the following year’s IRM study.

Preliminary base case assumptions are approved by ICS and the Executive Committee in early July. Final base case assumptions, including assumption changes that may occur after approval of the preliminary base case assumption matrix, are approved in early October. Substantive assumption changes that are identified after final base case assumption approval (base case assumption “lock-down”) are combined into a single Special Sensitivity Case (see Table 2-1 and Section 3.6) that is approved by ICS.

3.5.1 NYCA Load Model

The NYCA load model consists of the forecast NYCA and zone peak loads for the next capability year, and load shape and load uncertainty models.

Peak Loads

The NYISO provides peak and zone load forecasts for the next capability period. The NYISO will provide a preliminary load forecast – as published in the NYISO “Gold Book” – to ICS as part of an initial data base for use in the preliminary base case. Following the summer period, the NYISO develops a ~~Fall~~ forecast recognizing actual load conditions experienced during this most recent summer. This forecast should be available to the NYSRC by October 1 for use in the final base case (see Section 2.2).

Load Shape Model

The ~~yearly~~ load ~~shapes~~ that ~~is~~ input to the MARS program ~~consists~~ of ~~a~~ multiple 8,760 hour chronological ~~model~~s. The appropriate load shape ~~model~~ years used for the IRM study ~~is~~ developed by NYISO and reviewed by ICS ~~after reviewing~~. ~~The NYISO’s recommendation may consider~~ historical NYCA and zonal load shapes, weather characteristics, and ~~trends~~ other statistics from a minimum of the past ten ~~or more~~ years. ~~From this review, ICS adopts an appropriate year for the analysis after years.~~ After consultation with the NYISO. ~~The load shapes for the 11 zones are hourly aggregates of sub-zone loads. Sub-zone loads are developed by applying appropriate weights to the transmission district load shapes, the ICS adopts the appropriate load shape years for the IRM study.~~

Load Forecast Uncertainty Model

The load forecast uncertainty (LFU) model captures the impacts of weather and economic conditions on future loads. The LFU gives the MARS program information regarding seven load levels (three loads lower and three loads higher than the median peak) and their respective probabilities of occurrence. Each modeled hour, the MARS program determines the resource adequacy and calculates an average for the year for all seven load levels. MARS uses this information to evaluate a probability weighted-average LOLE for each area. Recognizing the unique LFU nature of individual NYCA zones, the LFU model is subdivided into four separate areas: New York City, Long Island, Westchester, and the rest of New York State.

Preparation of the LFU model is coordinated by the NYISO in collaboration with the TOs. The process used to develop the LFU model generally follows the procedure used to calculate the forecasted NYCA ICAP peak as described in the *NYISO Load Forecasting Manual*. This process follows the development of the NYCA peak, insofar as the LFU is a distribution, not a point

estimate. Following acceptance from the NYISO Load Forecasting Task Force, the NYISO submits the final LFU model to be used in MARS to ICS for review and approval.

The LFU model is built in three steps: The first step creates a relationship between a weather metric and the summer peak load for each zone using as many years of historical data as is available. The second step relates the same weather metric with the daily peak load historical data of selected years that are not older than 10 years. The third step combines the correlations found in the first and second steps to produce a relationship of expected yearly peak load in a per unit base and its probability of occurrence.

3.5.2 NYCA Capacity Model

The capacity model input to MARS incorporates the several types of resource capacity used to serve load in the NYCA. This section describes how each resource type is modeled in MARS.

Generating Units

The capacity model includes all NYCA generating units, including new and planned units, as well as units that are physically outside New York State. This model requires the following input data:

Unit Ratings. The rating for each generating unit is ~~based on its~~ the smaller of the reported Dependable Maximum Net Capability (DMNC). The source of DMNC ratings is seasonal tests required by procedures in the NYISO Installed rating or the Capacity Manual Resource Interconnection Service (CRIS) value. The annual NYCA Load and Capacity Report, issued by the NYISO, is the source of those generating units and their ratings included in the capacity model.

Retirements of existing generating units are considered when updating the capacity model. Appendix C provides guidelines for determining retirements.

Unit Performance. Performance data for all generating units in the model includes forced and partial outages, which are modeled by inputting a multi-state outage model that is representative of the “equivalent demand forced outage rate” (EFORd) for each unit represented. The MARS program uses state transition rates and the development of generator transition rates matrices. The source of this data is outage data collected by the NYISO from generator owners using availability data reporting requirements in the NYISO Installed Capacity Manual. The multi-state model for each unit is derived from the collection of forced and partial outages that occur over the most recent five-year period using benchmarked ~~NYISO translation software~~ GADS Open Source (OS) described in Appendix E. The appropriate historic time period should be periodically evaluated.

In addition to using actual outage data as the basis for representing EFORd in the capacity model, there are two circumstances when non-historic data may be used. First, the performance projection for a new or planned unit should be based on NYCA experience with similar units and/or NERC class-averages for the type and size of the unit. Second, the NYISO utilizes a GADS screening process for reviewing the accuracy of outage data it has collected from Generator Owners. From the results of this screening process, the NYISO may recommend to ICS the replacement of misreported or suspect data with proxy data.

Another generating unit performance parameter to be modeled for each unit is scheduled maintenance. This parameter includes both planned and maintenance outage components. The planned outage component is obtained from the generator owners, and where necessary, extended

so that the scheduled maintenance period equals the historical average using the same period used to determine EFORD averages.

The historical summer maintenance is also reviewed to determine, on average, how many MW were on a maintenance outage on high load days. This value is used to determine how many generating units should be modeled on maintenance over the summer peak load period. For purposes of this review the summer peak load period is July, August, and September up to Labor Day of the Capability Year being studied.

Thermal Unit Output Correction when Design Temperature Conditions are Exceeded. Models of thermal unit deratings due to temperature in excess of DMNC test conditions are developed based on two parameters. The first parameter relates NYCA load to temperature, while the second parameter relates thermal unit deratings to temperatures above DMNC conditions.

Hydro Units. The Niagara and St. Lawrence hydroelectric projects are modeled with a probability capacity model that is based on historical water flows and unit performance. The remaining hydro facilities are represented in MARS with a hydro derate model. This model represents hydro deratings in accordance with recent historical hydro water conditions.

Wind and Solar Units. Wind and solar units are renewable resources that are modeled as hourly load modifiers. The output of the wind and solar facilities are based on production profiles derived from existing facilities operating within the NYCA. Non-variable renewables, such as refuse or wood burning facilities are modeled as thermal generating units.

Special Case Resources and Emergency Demand Response Program

Special Case Resources (SCRs) are loads capable of being interrupted on demand, and distributed generators, rated at 100 kW or higher, that are not visible to the NYISO's Market Information System. The Emergency Demand Response Program (EDRP) is a separate program that allows registered interruptible loads and standby generators to participate on a voluntary basis and be paid for their ability to restore operating reserves.

The capacity from these programs is based on NYISO projections for the coming capability period. These projections are based upon escalating the Installed Capacity level of the current year's SCR program by the average annual growth rate in the Installed Capacity level of the SCR program over the past three years.

Due to the possibility that some of the potential SCR and EDRP program capacity may not be available during peak periods, NYISO projections are discounted based on previous experience with these programs (including years where there have been demand response events) as well as any operating limitations. Both EDRP and SCR programs are modeled as EOP steps, with a maximum number of calls per month so designated for EDRP programs. SCRs, however, because of their obligatory nature, are considered capacity resources in setting the IRM, while EDRP, like other EOP steps such as voltage reductions, are not considered capacity resources.

External Installed Capacity from Contracts

~~An input to the study is the amount of NYCA installed capacity that is assumed to be located outside of NYCA. Some of this capacity is grandfathered. The NYISO recommends the amount~~

~~of external capacity to be used in the base case based on projections for the coming capability period and NYISO Installed Capacity Manual procedures.~~

Sales

~~The NYISO recommends to ICS the inter-area capacity transactions to be modeled in the study.~~

Unforced Capacity Deliverability Rights (UDRs)

UDRs are capacity rights that allow the holder/owner to receive the Locational Capacity Benefit derived by the NYCA from the addition of a new incremental controllable transmission project that provides a transmission interface to a NYCA locality or zone. The owner/holder of these UDR facility rights must designate how they will be treated by the NYSRC and NYISO in the NYCA IRM and LCR studies, in accordance with the time schedule specified in the NYISO ICAP Manual. The NYISO calculates the actual UDR award based on the transfer capability of the facility and other data.

The holder/owner of the UDR facility currently has the option on an annual basis of selecting the MW quantity of UDRs (ICAP) it plans on utilizing for capacity contracts over its controllable line which counts towards meeting locational and installed capacity requirements, with any remaining capability on the controllable line used to support emergency assistance.

External Installed Capacity from Contracts

An input to the study is the amount of NYCA installed capacity that is assumed to be located outside of NYCA. Some of this capacity is grandfathered. The amount of external capacity imports modeled in the IRM study is limited to the grandfathered contracts only. The NYISO, during its import rights processes, will allow additional imports of MW to the extent it would not impact the IRM results, per A-R3, and as determined in accordance with its rules and procedures.

Sales

The NYISO presents to ICS the inter-area capacity transactions to be modeled in the study.

Environmental Regulations

Environmental regulations may restrict the availability of generating units during certain time periods. Accordingly, the capacity model reflects implementation of environmental initiatives. The NYISO RNA or other NYISO references are used as the source for developing appropriate generating unit performance models for recognizing environmental regulation impacts.

3.5.3 Emergency Operating Procedures (EOPs)

The NYISO initiates emergency steps when its operating reserve levels approach critical levels. Such EOPs are modeled in IRM studies. The EOP steps consist of those load control and generation supplements that can be implemented before load must be disconnected due to capacity shortages. Load control measures include implementation of SCR and EDRP programs, public appeals to reduce demand, and voltage reduction. Generation supplements could include emergency purchases and cutting operating reserves. The benefit from each of these emergency steps can either be expressed as a percentage of load or in MW. The NYISO recommends to ICS the EOP steps and related capacity values to be represented in the base case, based on operating experience with these measures.

Formatted: Normal

Formatted: Underline

3.5.4 Transmission System Model

The transmission system is modeled through emergency transfer limits in the interfaces between pairs of NYCA zones, or between NYCA zones and Outside World Areas. These emergency transfer limits are developed in accordance with NYSRC Reliability Rules B-R1, B-R2 and B-R3, Thermal, Voltage and Stability Assessments, respectively. The transfer limits are specified for each direction of the interface. Forced outage rates on cable interfaces in southeast New York are modeled in the same manner as generating unit outages, through the use of transition rates. These outage rates are determined and provided by the transmission owners. Certain interfaces are grouped to reflect the maximum simultaneous flow through these interfaces. The NYISO updates the transmission system model annually in accordance with the IRM database schedule in Section 2.2.

Preparation of the transmission system model requires review and acceptance by the NYISO Transmission Advisory Subcommittee before it is delivered to the NYSRC for use in IRM studies.

3.5.5 Locational Capacity Requirements

The MARS model used in the IRM study provides an assessment of the adequacy of the NYCA transmission system to deliver energy from one zone to another for meeting load requirements. Previous studies have identified transmission constraints into certain zones that could impact the LOLE of these zones, as well as the statewide LOLE. To minimize these potential LOLE impacts and to ensure that sufficient energy and capacity are available in that zone and that NYSRC Reliability Rules are met these zones require a minimum portion of their NYCA ICAP requirements to be electrically located within the zone, (i.e., locational ICAP). Locational ICAP requirements are currently applicable to two transmission constrained zones, New York City and Long Island, and are normally expressed as a percentage of each zone's annual peak load.

These locational ICAP requirements, recognized by NYSRC Reliability Rule A-R2 and established by the NYISO in accordance with the NYSRC/NYISO Agreement and the NYISO's tariff, complement the statewide IRM requirement. The Locational Installed Capacity Requirement Study performed by NYISO determines LSE requirements for affected zones. As with the IRM Study, the NYISO utilizes the Unified Method for these analyses (see Section 3.4.1) while using nominally the same data base. Differences between these databases, if any, are described in an annual NYISO study report in accordance with NYSRC Reliability Rules A-R1 and A-R2 and as specified by Measurement A-M2. Appendix D describes the procedure used by ICS to align, if necessary, the base case to the Final IRM, in preparation for the LCR Study by the NYISO.

3.5.6 Outside World Area Load and Capacity Models

The reliability of NYCA depends on a large extent on emergency assistance from the Outside World Areas in NPCC and PJM, based on reserve sharing agreements. Therefore, load and capacity models of the Outside World Areas are represented in the MARS analyses. The load and capacity models for New England, PJM, Ontario, and Quebec are based on data received directly from the Outside World Areas. Another source of Outside World data is the most current MARS data base used in NPCC studies, provided by NPCC on request. The latest model information available for representation of external areas will be utilized (see Table 2-1).

The primary consideration for developing the final load and capacity models for the Outside World Areas is to avoid overdependence on the Outside World Areas for emergency capacity support. For this purpose, a rule is applied whereby an Outside World Area's LOLE cannot be lower than its own LOLE criterion, its isolated LOLE cannot be lower than that of the NYCA, and its IRM can be no higher than that Area's minimum requirement. In addition, EOPs are not represented in Outside World Area capacity models. This is because there are uncertainties associated with the performance and availability of these resources and the ability to deliver them to NYCA boundaries during a system emergency event, as well as recognition of other unknowns in the external control area modeling representation.

Another consideration for developing models for the Outside World Areas is to recognize internal transmission constraints within the Outside World Areas that may limit emergency assistance to the NYCA. This recognition is considered either explicitly, or through direct multi-area modeling providing there is adequate data available to accurately model transmission interfaces and load areas within these Outside World Areas.

As with the NYCA, an appropriate historical year is chosen for selecting the Outside World Area load shapes. This decision should depend on what year is chosen to represent NYCA's load shape, review of the years chosen by NPCC and PJM for their studies, and other factors. In order to avoid overdependence from emergency assistance from Outside World Areas, the day of an Outside World Area's highest and second and third highest summer loads should be specified in the load model to match the same load sequence as that of NYCA.

3.6 Sensitivity Analysis

In addition to running a base case using the input assumptions described in Section 3.5, sensitivity studies are run to determine reserve margin requirement outcomes if using different assumptions than in the base case. Sensitivity studies provide a mechanism for illustrating "cause and effect" of how some performance and/or operating parameters and study assumptions can impact reliability. Certain sensitivity studies also serve to inform the NYSRC Executive Committee of how the IRM may be affected by deviations from selected base cases assumptions (see Section 4). Various types of sensitivity studies are grouped as follows:

MARS Parameter Impacts – This type of sensitivity study illustrates how MARS evaluations and IRM requirements are impacted by not representing certain modeling parameters within MARS. Examples of these sensitivity studies that could be considered are: NYS transmission system capability not represented, i.e., transmission constraints not represented within NYCA; interconnections to Outside World Areas not represented, i.e., no emergency assistance to NYCA; and load forecast uncertainty not represented.

Assumption Uncertainty Impacts – This type of sensitivity study illustrates the IRM impacts of recognizing the uncertainty of certain base case assumptions described in Section 3.5. These sensitivity studies are normally represented in pairs of high and low assumption ranges related to selected base case assumptions. Occasionally, sensitivity studies in this group are run when alternatives or disagreement may have existed during preparation of base case input assumptions. Examples of these sensitivity studies that could be considered are: higher and lower Outside World



Area reserves than represented in the base case, higher and lower generating unit EFORs than represented in the base case, and wheel through transactions. Each sensitivity case is defined by representing a reasonable range of assumptions higher and/or lower than the base case value.

Impacts of Future System Changes – This type of sensitivity study is sometimes considered to illustrate the impact of possible system changes that could be expected beyond the next capability period. An example of this type of sensitivity would be to examine the IRM impacts of future environmental initiatives.

Special Sensitivity Case – All substantive assumption changes following approval of the final base assumptions in early October are combined into a single Special Sensitivity Case (see Table 2-1 and Section 3.5).

An IRM study's preliminary base case is used to run sensitivity studies (See Section 3.4).

3.7 Data Base Confidentiality

A confidentiality agreement is in place to prevent disclosure of market sensitive data and data confidentially. FERC Order 889 Code of Conduct rules apply to NYSRC representatives with access to IRM Data Base. From time to time changes in the confidentiality agreement may be made.

Formatted: Normal

3.8 Standard Error

Another step in assuring quality result is to determine whether the standard error is acceptable. To this end, the MARS model is run for 1,000 iterations. If at the 1,000th iteration the desired standard error of 0.025 of the mean LOLE for calculating the 95% confidence level is not achieved, then increase the number of iterations in increments of 250 until the desired standard error is met or exceeded. If the 0.025 mark is met, the number of iterations for all MARS runs in the current year study is maintained. If the number of iterations has changed from the previous year, the ICS will be notified.

\$

3.9 Data Base Quality Assurance

It is critical that the data base used for IRM studies undergo sufficient review by the NYSRC and NYISO in order to verify its accuracy. To accomplish this objective, the NYSRC process for preparing an IRM study base case utilizes a method for reviewing the data base, while respecting confidentiality issues (see Section 3.7).

The NYISO and General Electric both conduct preliminary data quality assurance reviews as soon as base case assumptions are developed and prior to preparation of a preliminary base case. An additional data review is conducted by the NYISO, General Electric, and transmission owners prior to preparation of the final base case. Masked and encrypted input data is provided by the NYISO to the transmission owners for their reviews. Any data found to be in error by these reviews

is corrected before being used in the final base case. Results of quality assurance reviews are reported to ICS. Additional quality assurance reviews are conducted as deemed necessary by ICS.

In addition to above processes to review the IRM base case, the NYISO has its internal processes to evaluate whether the data supplied by Market Participants is consistent with NYISO procedures.

Section 4: Responsibilities

This section describes the responsibilities for providing and developing input data and modeling assumptions, conducting the NYCA IRM studies, and establishing the required IRM as described in Section 3. There are four entities having such responsibilities: ICS, NYISO, Market Participants, and the NYSRC Executive Committee.

4.1 Installed Capacity Subcommittee

The ICS has the overall responsibility of managing studies and preparing reports for establishing NYCA installed capacity requirements. Specific responsibilities include:

- Develop and approve all modeling and database assumptions to be used in the reliability calculation process. These assumptions include load models, representation of NYPA generating units and other types of resource capacity, emergency operating procedures, transmission representation, and Outside World Area models (see Section 3.5). Review proposed major modeling enhancements to ensure technical accuracy and implementation meets study schedule requirements.
- Approve the version of the MARS program to be used for the study (see Section 3.2).
- Manage conduct of MARS cases for developing the preliminary and final base cases, including benchmarking requirements.
- Recommend to the Executive Committee the sensitivity studies to be run (see Section 3.6).
- Together with NYISO staff, review and ensure database accuracy (see Section 3.5.7).
- Ensure that the timeline requirements in Section 2.2 are met.
- Arrange for supplemental computer facilities as needed.
- Prepare status reports and the IRM Study for NYSRC Executive Committee review.
- Coordinate above activities with NYISO staff.

4.2 NYISO

The NYSRC relies on the NYISO to provide sufficient technical and computer support for the IRM Study effort. The basis for this support is provided in the NYISO/NYSRC Agreement. The NYISO leases the MARS computer program used for the reliability calculation studies. The NYISO utilizes the same program and NYSRC assumptions from the IRM Study for its own study of LSE locational capacity requirements.

- Conduct MARS studies for the IRM Study as requested by ICS.

- Develop load, capacity, transmission, and EOP models and supporting data for consideration by ICS for use in the IRM study and report. This information should be provided to ICS so as to allow the timeline requirements in Section 2.2 to be met. The NYISO should make recommendations to ICS concerning the application of these models in the IRM Study. Collaborate with ICS to prepare white papers describing proposed major modeling enhancements.
- Together with ICS, review and ensure database accuracy. Retain General Electric to assist in this review.
- Benchmark new versions of MARS.
- Obtain technical support for the application of MARS for IRM studies from General Electric, as well as other outside entities, as required.

4.3 Market Participants

Market Participants are knowledgeable concerning load information, planned resource capacity additions, and how the transmission system should be represented in IRM studies. Market Participants have the responsibility to provide such information to the NYISO for use in the IRM studies. Transmission Owner representatives participate in review of database accuracy.

4.4 NYSRC Executive Committee

The NYSRC Executive Committee has the responsibility of approving the final IRM requirements for the next capability year.

- Review and approve preliminary and final base case assumptions and models -for use in IRM Study.
- Review preliminary base case IRM results.
- Approve sensitivity studies to be run and their results.
- Review and approve the IRM Study prepared by ICS.
- Establish and approve the final NYCA IRM requirement for the next capability year (see Section 5).
- To the extent practicable, ensure that the schedule for the above approvals allow that the timeline requirements in Section 2.2 are met.
- Notify the NYISO of the NYCA IRM requirements and meet with NYISO management as required to review IRM Study results.
- Make IRM Study results available to state and federal regulatory agencies and to the general public by posting the study on the NYSRC Web site.

Section 5: Establishment of the Final IRM

5.1 Consideration of IRM Study Results

The process utilized by the NYSRC Executive Committee for establishing the Final IRM of the following capability year includes consideration of the Final IRM base case study results and the sensitivity studies, based on the procedures and models described in Section 3, as well as other relevant factors. Following a full discussion of the base case study results, the sensitivity studies, and other factors considered by Executive Committee members to be relevant, the Executive Committee proceeds to vote on the Final IRM value. The sensitivity studies serve to inform the Executive Committee of how the base case IRM might be affected, in either direction, by deviations from selected assumptions. The IRM Study represents the Executive Committee's best judgment with respect to the base case assumptions that should be used in developing the base case IRM. The weight, if any, accorded one or more sensitivity studies in establishing a Final IRM will be determined by Executive Committee members based on the relevant circumstances. The Final IRM adopted by the Executive Committee will comply with the NYSRC resource adequacy criterion.

5.2 Executive Committee IRM Voting Procedure

1. The Executive Committee will conduct a full discussion of the IRM Study, the base case IRM, and the sensitivity studies, in which the Executive Committee members will have an opportunity to express their views.
2. Following the discussion of the IRM Study, the base case IRM, and the sensitivity studies, a secret straw poll will be taken in which each Executive Committee member will indicate the IRM the member supports as the final IRM based on the discussion of the IRM Study, the base case IRM, and the sensitivity studies. Recommended IRMs different from the base case IRM will be expressed in increments higher or lower than the base case IRM rounded to the nearest whole or half integer. The Executive Secretary will announce only the IRM that received the most votes. The Executive Committee will then vote on the IRM that received the most votes in the straw poll. If the nine votes necessary to approved are not received, a vote will be taken on the IRM that received the second most votes, and so on.
3. If there is a tie in the straw poll, the IRM first voted on will be the IRM that is closest to the base case IRM. If the IRMs are equally close to the base case IRM, the IRM that is closest to the current IRM will be voted on first. If the IRMs are equally close to the base case IRM and the current IRM, the Executive Secretary will announce a tie vote and the IRMs receiving the highest number of votes, and request a new secret straw poll to break the tie. If the tie is not broken, the Chairman will decide which IRM will be voted on first.
3. The Executive Secretary will distribute printed ballots for each vote which will indicate the subject of the vote, the identity of the Executive Committee member voting, and the member's vote. The Executive Secretary will tabulate the votes and announce the results, but not how individual Executive Committee members voted. The tabulation of the vote will be confirmed by the Counsel to the NYSRC. The Executive Secretary and the Counsel will treat the votes by individual Executive Committee members as confidential information not to be disclosed to any Executive Committee member or any other party, except on the express direction of the Executive Committee. The Executive Secretary will retain the voting records for a period of three years.

5. Once an IRM has achieved the votes needed for approval, a secret confirmation vote may be held at the request of an Executive Committee member.
6. Once approved by the Executive Committee, an IRM will remain in effect until a subsequent IRM is approved by the Executive Committee. Consequently, should the Executive Committee not adopt a Final IRM for a particular capability year, the IRM currently in effect will remain in effect for that capability year.

APPENDIX A
Unified Methodology Description
~~Unified Methodology Description~~



Formatted: Justified

1.0 Introduction

Appendix A describes a procedure to develop the statewide Installed Reserve Margin (IRM) versus Minimum Locational Capacity Requirements (LCRs) curves.

Within the New York Control Area (NYCA) there are currently two zones identified as localities to which this procedure would apply. They are the New York City and Long Island zones.

2.0 Initial Conditions

- 2.1. A Multi-Area Reliability Simulation (MARS) base case database exists for the upcoming capability year.
- 2.2. Localities in the NYCA that require minimum LCR have been identified (in Section 1).
- 2.3. Any capacities that have been shifted, removed, or added to arrive at the base case for the IRM study should be reset to the “as found” case before initiating this procedure. This procedure should start with the forecast capacities, and forecast loads.

3.0 Setting up the base case model for a desired study reserve margin (SRM)

Installed capacity (ICAP) is either added to or removed from zones west of the Total East Interface that have excess capacity reserves (capacity rich zones) so that the statewide capacity to peak load ratio equals the desired study reserve margin (SRM) point.

- 3.1. A portion of this installed capacity (ICAP) is added to or removed from each capacity rich zone. The amount to be added to or removed from each capacity rich zone is based on the ratio of its excess unforced capacity (UCAP) to the total excess unforced capacity (UCAP) of all capacity rich zones.
- 3.2. Capacity removal or addition is achieved by adjusting the respective entry for each capacity rich zone in the MOD-MDMW table of the MARS program. The amount entered in the table is the equivalent UCAP amount for the amount of ICAP to be removed or added. UCAP for a zone is equal to the ICAP for that zone times one minus the weighted equivalent forced outage rate (1-EFOR) for the zone.
- 3.3. The correct amount of ICAP added to or removed from NYCA should be verified by performing a single iteration MARS run using the capacity adjusted model, checking the total capacity from the MARS 07 output file, and calculating the achieved reserve margin.

- 3.4. Run ~~at the MARS simulation until the model for 1,000 iterations. If at the 1000th iteration the desired standard error of the LOLE index is less than or equal to 0.05 or when the maximum number 25 of replications has been reached. Record the NYCA mean LOLE risk. (Note, since for calculating the NYCA model may converge well before 95% confidence level is not achieved, the usual 1500 replications, a minimum NYISO will notify the ICS and then increase the number of iterations may be specified to ensure a minimum number of samples in increments 250 until the desired standard error is collected.) met or exceeded.~~

4.0 Determination of the initial target capacity for each locality

Formatted: Font: Times New Roman

Formatted: Font: Times New Roman

Formatted: Font: Times New Roman

Formatted: Font: Times New Roman

Formatted: Font: Times New Roman

Formatted: Font: Times New Roman

Formatted: Font: Times New Roman

Formatted: Font: Times New Roman

Formatted: Font: Times New Roman

Formatted: Font: Times New Roman

Formatted: Font: Times New Roman

The initial target capacity for a locality is the maximum capacity that is shifted from or to the locality to yield a NYCA LOLE risk of 0.1 days/year, while all other zones and localities remain unchanged.

- 4.1. Using the capacity adjusted base case from Section 3 as the base model, if the LOLE for the base case is less or greater than 0.1 days/year, remove or add respectively a trial amount of ICAP from or to the locality being considered.
- 4.2. The equivalent UCAP amount to be added to or removed from the locality is entered in the respective entry for the locality in the MOD-MDMW table of the MARS program.
- 4.3. To maintain the same desired reserve margin, the same ICAP amount should be removed from or added to the capacity rich zones using the steps in Section 3.0.
- 4.4. Run a MARS simulation until the standard error of the LOLE index is less than or equal to 0.05025 or when the maximum number of replications has been reached.
- 4.5. If the NYCA LOLE is below or above 0.1 days/year, repeat Sections 4.1 to 4.4 with a higher or lower trial amount of ICAP until the NYCA LOLE reaches 0.1 days/year or within an acceptable range.
- 4.6. Record the total amount of ICAP added to or removed from the locality being considered. This is the initial target capacity for the locality.
- 4.7. If a NYCA LOLE of 0.1 days/year cannot be achieved either by shifting capacity to or from the locality, the desired SRM is not achievable and a new SRM should be selected and repeat steps in Section 3.
- 4.8. If a NYCA LOLE of 0.1 days/year is achieved for the locality, repeat the steps in Sections 4.1 to 4.7 for each identified locality and record the amount of ICAP capacity shift for each of these localities. These are the initial target capacities for the zones. (Before considering a new locality, reset the model to the original capacity adjusted base case, i.e. with the desired reserve margin, as described in Section 3.0)

Formatted: Font: Times New Roman

5.0 Determination of the capacity multiplier for each locality

Formatted: Font: Times New Roman

The capacity multiplier for an identified locality is the initial target capacity for the locality, obtained in Section 4, divided by the sum of the initial target capacities for all the identified localities. These multipliers determine the portion of the total installed capacities to be shifted for each identified locality. For example, if zones 1 and 2 are the only two localities identified, and the initial target capacities for zones 1 and 2 are 300 MW and 100 MW respectively, then the capacity multiplier for zone 1 would be 300/400 or 0.75, while the capacity multiplier for zone 2 would be 100/400 or 0.25.

6.0 Determination of the actual capacity removal or addition for each locality

Formatted: Font: Times New Roman

- 6.1. Based on the initial LOLE risk for the capacity adjusted based model obtained in Section 3, estimate a total trial amount of ICAP to be shifted from or to the identified localities.
- 6.2. This trial amount of capacity will be shifted from or to the identified localities using the capacity multipliers obtained in Section 5.0. For example, using the example in Section 5.0, if 1000 MW is to be removed from zones 1 and 2, then the amount of ICAP to be removed from zone 1 would be $1000 * 0.75$ or 750 MW, and for zone 2, 250 MW respectively.
- 6.3. The equivalent amount of UCAP for each identified locality is then entered into the respective entries in the MOD-MDMW table of the MARS program.
- 6.4. To maintain the desired SRM, the same amount of ICAP capacity must be shifted to or from the capacity rich zones. The amount of equivalent UCAP entries for each of the capacity rich zones in the MOD-MDMW table can be determined using the same steps described in Section 3.
- 6.5. Run a MARS simulation until the standard error of the LOLE index is less than or equal to ~~0.05~~0.025 or when the maximum number of replications has been reached. Record the NYCA LOLE risk.
- 6.6. If the NYCA LOLE risk is below or above 0.1 days/year, increase or decrease the trial amount of ICAP to be shifted from or to the identified localities. Repeat Sections 6.2 to 6.5 until the NYCA LOLE reaches 0.1 days/year or within an acceptable range.
- 6.7. Record the amount of ICAP shifted from or to each identified locality. The remaining amount of ICAP in each identified locality is the total generation in the locality, minus or plus the amount shifted for that locality.

Formatted: Font: Times New Roman

7.0 Determination of the locational capacity requirement (LCR) for each identified locality

Formatted: Font: Times New Roman

The locational capacity requirement (LCR) for the desired SRM for each identified locality is the ratio, expressed as a percentage, of the remaining amount of ICAP in each identified locality, obtained in Section 6.7, to the forecast peak load of the locality.

8.0 Determination of the LCR-IRM curves

Repeat Sections 3.0 to 7.0 to provide the resulting LCRs for a range of desired reserve margins. The results will be used to plot the LCR-IRM curves and determine the desired NYCA LCR-IRM as described in Appendix B.

APPENDIX B
Selection of Tan 45 Points on the IRM/LCR Curves
Established by the Unified Methodology

Formatted Table

The IRM Anchoring Method identifies the NYCA IRM Requirements and related MLCR from IRM/LCR curves established by the Unified Methodology. The *anchor point* on the curve is selected by applying a tangent of 45 degrees (“Tan 45”) analysis at the bend (or “knee”) of the curve as shown on Figure B-1 below. Based on these curves, extreme points on the curve on either side of the Tan 45 point may create disproportionate changes in LCR and IRM, since small changes in LCR can introduce larger changes in IRM Requirements and vice versa. A regression analysis is utilized to best fit the IRM/LCR curves and determine the Tan 45 point, rather than a visual inspection of the curves.

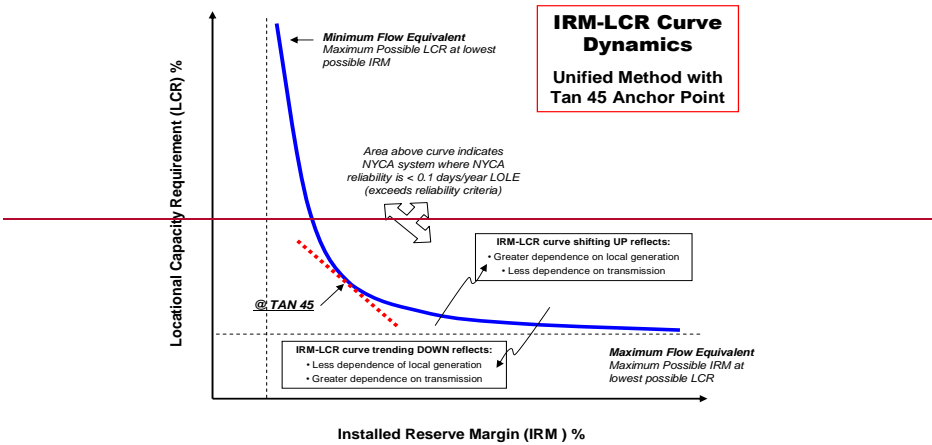

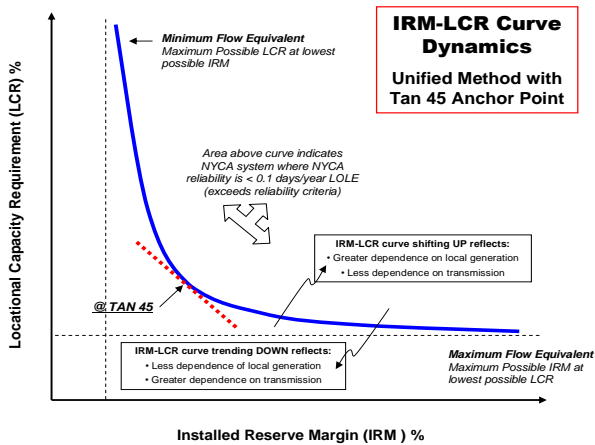

**Figure B-1: IRM-LCR Unified Method Curve Dynamics
With Tan 45 Anchor Point**

The IRM/LCR characteristic consists of a curve function, “a knee of the curve” and straight line segments at the asymptotes. The curve function is represented by a quadratic (second order) curve which is the basis for the Tan 45 inflection point calculation. Inclusion of IRM/LCR point pairs remote to the “knee of the curve” may impact the calculation of the quadratic curve function used for the Tan 45 calculation.

The procedure for determining the best fit curve function used for the calculation of the Tan 45 inflection point to define the base case requirement is based on the following methodology:

- 1) Start with all points on IRM/LCR Characteristic.
- 2) Develop regression curve equations for all different point to point segments consisting of at least four consecutive points.
- 3) Rank all the regression curve equations based on the following:
 - Sort regression equations with highest R^2 .
 - Ensure calculated IRM is within the selected point pair range, i.e., if the curve fit was developed between 14% and 18% and the calculated IRM is 13.9%, the calculation is invalid.
 - In addition, there must be at least one statewide reserve margin point to the left and right of the calculated tan 45 point

- Ensure the calculated IRM and corresponding LCR do not violate the 0.1 LOLE criteria.
- Check results to ensure they are consistent with visual inspection methodology used in past years studies.

This approach identifies the quadratic curve functions with highest R^2 correlations as the basis for the Tan 45 calculation. The final IRM is obtained by averaging the Tan 45 IRM points of the NYC and LI curves. The Tan 45 points are determined by solving for the first derivatives of each of the “best fit” quadratic functions as a slope of -1. Lastly, the resulting MLCR values are identified.

APPENDIX C

Retirement Guidelines

APPENDIX C
Guidelines Retirement

1. The IRM study base case will be updated to remove a generation unit if:
 - 1.1. All of the following:
 - 1.1.1. By the study's lock down date² for assumptions, the unit owner has provided notice of the retirement, mothball, protective layup, or any other situation where the generator has been or will be removed from service pursuant to the PSC Retirement Order; and
 - 1.1.2. A reliability analysis has been conducted by the NYISO or the local Transmission Owner (TO) pursuant to the PSC Retirement Order and NYISO Technical Bulletin 185, which has determined, by the lock down date, that the retirement will not give rise to a bulk power system or a local reliability need; and
 - 1.1.3. the owner has not rescinded its previous retirement notice prior to the lock down date; and
 - 1.1.4. The retirement date of the unit is prior to or within the study period.
 - 1.2. Or, the unit is inoperable for the upcoming capability year, and at the time of the lockdown date, the owner has not indicated that it will return to service within the study period; or
 - 1.3. A reliability analysis has been conducted by the NYISO or the local Transmission Owner (TO) pursuant to the PSC Retirement Order and NYISO Technical Bulletin 185 which has determined that the retirement will give rise to a bulk power system or a local reliability need and a solution to the reliability need has been identified and is implementable by June 1st of the study year.
2. The IRM Study base case will not be updated to remove an operable unit that has provided notice of the retirement, mothball, etc., if by the lock down date:
 - 2.1. a NYISO led reliability analysis has not been completed; or
 - 2.2. a reliability analysis has been conducted by the NYISO or the local TO pursuant to the PSC Retirement Order and Technical Bulletin 185 which has determined that the retirement will give rise to a bulk power system or a local reliability need and no solution to the reliability need has been identified; or

² The lock down date is the date by which the ICS presents the final IRM base case assumptions matrix to the Executive Committee for approval (see Table 2-1).

- 2.3. an arrangement is in place for the unit to not exit the system; or
- 2.4. a date certain for return to service occurring within the study period has been accepted by the PSC, the TO, and the NYISO. Under this condition, the unit would be removed from the time it is scheduled to retire until the date certain.

APPENDIX D

**~~Procedure for Aligning the Base Case IRM to the Final IRM in Preparation
for the Locational Capacity Requirement Study by the NYISO~~**

APPENDIX D
**Procedure for Aligning the Base Case IRM to the Final IRM in Preparation
for the Locational Capacity Requirement Study by the NYISO**

The IRM base case model is used as the foundation for establishing the IRM, the Locational Capacity Requirements (LCRs), and for certain other NYISO reliability studies. Appendix D discusses the potential changes to the IRM base case model needed by the NYISO to conduct various NYISO studies, including the LCR Study.

Establishing Final IRMs above the Study's Base Case Results

When the NYSRC Executive Committee establishes a Final IRM that is higher than the IRM study's base case result, it is adding an IRM margin to the base case results. The purpose of this margin is to ensure, considering base case assumption uncertainties, that the NYSRC resource adequacy Loss of Load Expectation (LOLE) criterion is met at the Final IRM level. NYISO studies maintain this margin in using the IRM data base for calculating and setting the LCRs and External Capacity Rights.

Establishing Final IRMs below the Study's Base Case Results

When the NYSRC Executive Committee establishes a Final IRM that is lower than the base case IRM – after weighing consideration of sensitivity studies and other factors – it is confident that this lower IRM will meet the NYSRC resource adequacy criterion.

It is understood that in establishing LCRs the NYISO will calculate LCR values, that together with the Final IRM, will meet the NYSRC 0.100 LOLE criterion. Since the introduction of a lower IRM into the study's base case data base could result in a LOLE above the criterion, the data base is adjusted so as to maintain the 0.100 days/year LOLE criterion. This adjustment is accomplished by increasing the EDRP MW values modeled in each zone.

After completion of the above base case alignment analysis, the NYISO will prepare a report for ICS review, which includes a description of the adjusted EDRP MW values and other assumption changes, the resulting LOLE, and the calculated LCRs.

After ICS approves the base case alignment analysis, the base case database is provided to the NYISO for use in NYISO studies, including the LCR study described in Section 3.5.5.

Appendix E

Development of Generator Transition Rate Matrices for MARS that are Consistent with the EFORD Reliability Index

Formatted: Font: Cambria, 16 pt, Bold, Kern at 16 pt

Introduction

The GE MARS Program is based on a sequential Monte Carlo simulation which uses state transition rates, rather than state probabilities, to describe the random forced outages of the generating units. State probabilities give the probability of a unit being in a given capacity state at any particular time, and can be used if one assumes that the unit's capacity state for a given hour is independent of its state at any other hour. Sequential Monte Carlo simulation recognizes the fact that a unit's capacity state in a given hour is dependent on a given state in previous hours and influences its state in future hours. It thus requires additional information that is contained in the transition rate data.

The NYISO capacity market transacts in unforced capacity or UCAP. UCAP is determined by multiplying a generating resource's DMNC, or CRIS if less than DMNC, by its Equivalent Demand Forced Outage Rate (EFORD). EFORD is the industry standard index for determining generating unit performance in competitive markets. Because peaking units normally operate for relatively short periods of time, the basic two-state model was extended to a four-state representation in order to recognize this behavior. The Institute of Electrical and Electronic Engineers' (IEEE) four-state or EFORD model was developed in 1972 [1]. The EFORD is defined in the IEEE Standard 762 entitled: "IEEE Standard Definitions for Use in Reporting Electric Generating Unit Reliability, Availability, and Productivity" [9]. The standard can be found on nerc.com at the following link:

<http://www.nerc.com/docs/pc/gadstf/ieee762tf/762-2006.pdf>.

Measures of generating unit performance have been defined, recorded, and utilized by the electric power industry for several decades. The North American Electric Reliability Corporation (NERC)'s Generator Availability Data System (GADS) is the process utilized in the power industry for reporting generator performance data. Generating resources subject to mandatory reliability standards are required to report GADS data as described in NERC's "Data Reporting Instructions" [2]. The reporting instructions can be found at the following link:

<http://www.nerc.com/pa/RAPA/gads/Pages/Data%20Reporting%20Instructions.aspx>.

It is important that there be consistency between the EFORD calculations utilized in the NYISO capacity markets and MARS transition rate matrices. In order for the MARS LOLE simulation to be consistent with the EFORD calculations, the transition rate matrix needs to maintain the conditional state probabilities used in the EFORD calculation. Two approaches were developed by Dr. Chanan Singh of Associated Power Analysts (APA) and provided in APA's report [3], which provides the basis for the methodology described in Appendix E. Approach 1 with some modification was the one that was selected for implementation with the GADS Open Source software.

Assumptions for the Methodology

The purpose of the methodology is to develop transition rates that yield EFORd of the units which are consistent with the formulae used by NYISO's capacity markets. The main difficulty in this process lies in the fact that programs like MARS assume that the units are running all the time and there are no mechanisms in these programs to start the units during the period of need and put them on reserve shutdown when not needed. However, EFORd is computed based on the derated and forced outage states given the period of demand.

The following points are working assumptions that underlie the development of the MARS transition rate methodology:

1. Embedded in the EFORd calculation are the following three steps:
 - a. Finding times spent in various states during demand;
 - b. Converting these times into conditional probabilities;
 - c. Adjusting the times in derated states to equivalent times in the full forced outage state.
2. Under the present state of data collection, the accepted practice is to assume that the conditional probabilities calculated for EFORd procedure are the benchmark.
3. For the MARS calculations of LOLE to be consistent with the EFORd calculations, the transition rate matrix should maintain the conditional state probabilities used in the EFORd calculation.
4. MARS does not have mechanisms for starting units in response to demand or shutting down when not needed [4, 5]. Therefore, the program essentially assumes the units are running, in service, or in demand all the time.
5. To be consistent with the assumption of the units running all the time, models conditional on the demand should to be used.
6. The EFORd calculation formula is based on the conditional probabilities of the states and these conditional probabilities should be assumed as a good estimate of the performance. So, the transition rate matrix should be constructed to maintain these conditional probabilities. The conditional approach used in the four-state model [1] that forms the basis of EFORd calculations was in fact proposed to deal with the assumption of units running all the time.

Development of the Methodology

For ease of discussion, the methodology will be described using a unit with two derated states [10], which will later be extended to any number of derated states. The model in Figure E-1 is a representation of the state space of this unit with two derated capacity levels and one full outage level. The states during the reserve shutdown and demand are shown separately at all capacity levels. The service hours SH are then the hours spent in states 5, 6 and 7.

The hours spent in state i are denoted by H_i . Assume that the total time in a derated capacity state is known, but its components during demand and reserve shutdown are not known separately. For

example, the sum ($H_6 + H_2$) may be known, but not H_2 and H_6 individually. Consistent with the approach used for the EFORD calculation, the hours in the various derated states and down state during demand can be estimated as:

$$\underline{H_6 = (H_6 + H_2) f_p} \quad (1)$$

$$\underline{H_7 = (H_7 + H_3) f_p} \quad (2)$$

$$\underline{H_8 = (H_8 + H_4) f_r} \quad (3)$$

Knowing the components of derated times during demand,

$$\underline{H_5 = SH - H_6 - H_7} \quad (4)$$

The f factors used in these equations are defined in Appendix F of NERC’s “Data Reporting Instructions” [2] along with the equations for their calculations. Of course, if the data kept allows the knowledge of H_6 , H_7 , and/or H_8 individually, then there is no need to use the f factors. From a conceptual perspective it can be stated that it should be possible to keep such data for derated states as they are similar to the full capacity state except with reduced capacity. However, for the forced outage state it may be hard to assign when the transition to reserve shut down happens. This is because when the unit is forced out, one can only calculate when the duty cycle would have ended.

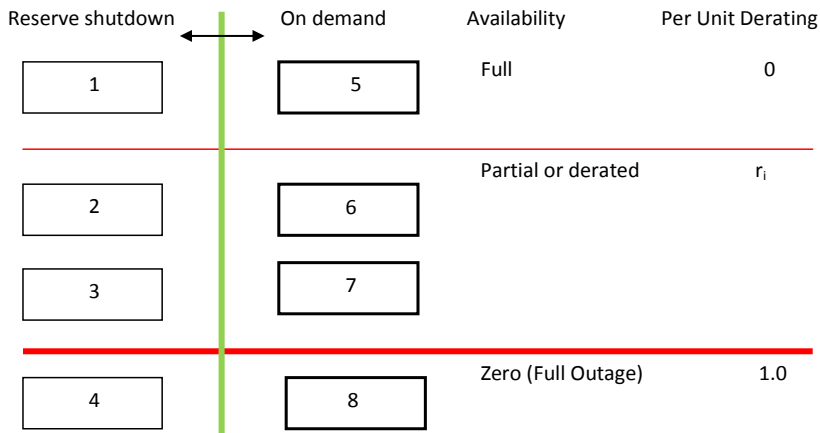

Figure E-1. States of a unit with two derated capacity levels

The conditional probabilities of states, 5 to 8, given demand can be estimated as

$$\underline{P5d = H5 / Sum} \quad (5)$$

$$\underline{P6d = H6 / Sum} \quad (6)$$

$$\underline{P7d = H7 / Sum} \quad (7)$$

$$\underline{P8d = H8 / Sum} \quad (8)$$

Where $Sum = H_5 + H_6 + H_7 + H_8$

The additional subscript d is used to indicate that these are probabilities given demand.

Field Code Changed

\$

The EFORD can be calculated from these probabilities as

$$\text{EFORD} = r_1 P_{6d} + r_2 P_{7d} + P_{8d} \quad (9)$$

It is reasonable to assume that in the absence of the programs to start and shut down units, the use of conditional probabilities given demand (equations (5)-(8)) for the states of the system is the appropriate approach. However, MARS uses transition rates to generate the history of the states of the units and it does not have a mechanism to start and shut down units. Therefore, transition rates are needed such that the conditional probabilities of states remain the same as given by equations (5)-(8).

If there are n states of the new unit, then the maximum number of frequency balance equations [6, 7, 11] is n-1 but the number of possible transition rates is n(n-1). It should be noted that the probability based indices like LOLE and EUE may not be affected by the choice of the solution for transition rates, but any frequency based index will be affected by the choice of transition rates.

Let's define an (n x n) matrix N such that its ijth element N_{ij} is the number of times the unit changes from state i to state j, then the transition rate from i to j is given by

$$\lambda_{ij} = N_{ij} / H_i \quad (10)$$

Where H_i is the time spent in state i.

Now the matrix N needs to satisfy the following property:

$$\sum_{j,j \neq i} N_{ij} = \sum_{i,i \neq j} N_{ij} \quad (11)$$

This equation ensures that the frequency of entering a state is the same as the frequency of exiting from the state [6-8]. Since in practice, the data may not be collected over a long enough time, equation (11) may only be approximately satisfied for every state. It should be noted that the column sum of N is the frequency of entering the state and the row sum is the frequency of exiting the state. So to ensure the frequency balance, the column sum for every state should be equal to its row sum.

MARS Transition Rate Methodology

The approach of the methodology can be generalized as follows. It is assumed that SH=Hours in the full capacity operating state + Derated Hours during the demand period.

1. Let there be n capacity states of the unit, state 1 with capacity of 1 pu, state n with 0 pu and states 2 to n-1 as derated states.
2. Determine the matrix N representing number of interstate transitions and it should satisfy the property given by equation (11) very closely.
3. The time in state 1 is given by

Field Code Changed

5

$$H_1 = SH - \text{Total Derated Hours} \times f_p$$

The time in the full outage state n is

$$H_n = FOH \times f_f$$

The times in derated states 2 to n-1 are given by

$$H_i = (\text{Hours in derated state } i) \times f_p$$

In these calculations, it is assumed that the times spent in a combined derated state (Reserve and Demand) are not individually known but their total (Reserve + Demand) is known. So, the individual times are found using the f_p factor just like in the EFORd calculation. If the times in the two components of a derated state (Reserve or Demand) are individually known, then they can be used instead of apportioning the times from the combined state by the f_p factor. **It should be noted that the times in the derated states can be individually known from the GADS data collected by the NYISO, which eliminates the need for the f_p factor in the NYISO implementation.**

4. Find the transition rates using

$$\lambda_{ij} = N_{ij} / H_i$$

The probabilities of states can be determined from the transition rate matrix and the EFORd can be calculated as

$$EFORd = P_n + \sum_{i=2}^{n-1} r_i P_i \quad (12)$$

Implementation and Validation of the MARS Transition Rate Methodology

In order to generate the metrics needed to populate the transition rate matrices for the generating units modeled in MARS, the above methodology was coded into the GADS Open Source software package but modified as described above. The GADS Open Source (GADS OS) is the software utilized by the NYISO to analyze generator performance data. It is used to calculate the generator performance indexes used in determining a generator's UCAP value and, now, for developing the transition rates that are used in the MARS model. GADS OS allows electric generating companies to collect and report validated GADS performance data and event data. GADS OS can be found at this link:

<http://gadsopensource.com/>

GADS OS, written by industry veteran Ron Fluegge, consists of two open source applications—GADS OS Data Entry and GADS OS Analysis & Reporting to analyze the GADS data. Besides the use of this software for submittal of GADS data to NERC and the NYISO, the software is also used for submittal of data to the ISO New England, PJM, and the MISO.

Field Code Changed

\$

Measures of generating unit performance—such as Availability Factor (AF), Equivalent Availability Factor (EAF), Forced Outage Rate (FOR), Equivalent Forced Outage Rate (EFOR), and Starting Reliability—have been defined, recorded, and utilized by the electric power industry for several decades. Analysis & Reporting not only calculates these important standard measures, but also includes measures such as the Equivalent Demand Forced Outage Rate (EFORd) used in UCAP/ICAP calculations that have been developed to respond to the deregulated capacity and energy markets.

GADS OS is already in use at a wide range of generating companies from single-plant sites to larger generating companies with hundreds of generating units. The latest count shows that the GADS OS code base is being used to collect and analyze data on more than 200 companies and 3,800 generating units both domestically and internationally.

In order to correctly calculate the transition rates of a unit using its historic events-data, its state durations need to be in a strictly seamless sequence without any overlapping. There will be little difficulty in calculations if the raw data events are in an ideal sequence, i.e., the beginning time of any event is equal to or later than the ending time of its previous event. However, it was found that in the raw data there are quite a few records indicating existence of overlapping events. In addition, some records even show discrepancies in the sequence of events, e.g., an event started and ended before the beginning time of its previous event. All these discrepancies in raw data will frustrate the standard programming algorithms and can cause erroneous calculation results.

As a result, two pretreatment procedures were developed before the raw events data can be used for calculating transition rates. When events in mistaken sequence are found, their places in the overall event sequence list will be reordered by the Pretreatment Procedure 1—Handling Mistaken Sequence of Events. Unless all mistaken sequence records of a unit are corrected, the next Pretreatment Procedure 2—Handling Overlapping Events should not begin.

In order to benchmark statistics in the performance data, Pretreatment Procedure 2 is based on the following classification of event priority levels.

<u>Priority Level</u>	<u>Event Types</u>	<u>Event Code in GADS</u>
<u>1st</u>	<u>Forced Outage, Startup Failure</u>	<u>U1, U2, U3, SF</u>
<u>2nd</u>	<u>Reserve Shutdown</u>	<u>RS</u>
<u>3rd</u>	<u>Planned Outage and its Extension, Maintenance Outage and its Extension</u>	<u>PO, PE, MO, ME</u>
<u>4th</u>	<u>Forced Derating (lower net available capacity)</u>	<u>D1, D2, D3</u>
<u>5th</u>	<u>Forced Derating (higher net available capacity)</u>	<u>D1, D2, D3</u>
<u>6th</u>	<u>Planned Derating and its Extension, Maintenance Derating and its Extension</u>	<u>PD, DP, D4, DM</u>
<u>7th</u>	<u>Noncurtailing Event</u>	<u>NC</u>
<u>8th</u>	<u>Full capacity (gaps between adjacent events)</u>	<u>--</u>

The different types of events in the same priority level are observed not to be overlapping data records. For any two adjacent overlapping events from different priority levels, four rules for appropriate handling are summarized as follows.

5

(1) If the lower priority event started before the beginning time of the higher priority event, and the lower priority event ended before or at the same time as the ending time of the higher priority event, adjust the ending time of the lower priority event benchmarking the beginning time of the higher priority event.

(2) If the lower priority event started before the beginning time of the higher priority event, and the lower priority event ended after the ending time of the higher priority event, replace the original lower priority event by two new separate events. For the first new event, inherit the beginning time of the original lower priority event as its beginning time, and adopt the beginning time of the higher priority event as its ending time. For the second new event, inherit the ending time of the original lower priority event as its ending time, and adopt the ending time of the higher priority event as its beginning time.

(3) If the lower priority event started at the same time as or after the beginning time of the higher priority event, and the lower priority event ended before or at the same time as the ending time of the higher priority event, invalidate the lower priority event for transition rate calculation.

(4) If the lower priority event started at the same time as or after the beginning time of the higher priority event, and the lower priority event ended after the ending time of the higher priority event, adjust the beginning time of the lower priority event benchmarking the ending time of the higher priority event.

After Pretreatment Procedure 2, an additional rule is also applied to eliminate possible human errors for raw data gaps. This is the Rule of Seamlessness: If the time gap between any two adjacent events is no greater than 1 minute, it will be ignored and the two events are considered as neighboring events. Otherwise, the time gap will be regarded as an event of full-capacity state existing between the two adjacent events.

It is important to note that all the derating states remaining in the sequential event list after above raw data pretreatment procedures are already separated from reserve shutdown states. Hence, these remaining derating states are actually in demand. When counting the total durations of these derating states for calculating transition rates, the f_p factor is no longer necessary. However, the f_r factor is still needed since there is no good way to distinguish in-demand or not-in-demand states when a unit is actually in a forced outage status.

The use of the APA methodology as coded in the GADS OS software with data pretreatment resulted in small differences (less than 0.6% of the total NYCA resources or approximately 225 MW) between the Market calculated EFORd and the GADS OS generated EFORd as implemented in GADS OS [12]. Most of these differences are accounted for in the data used for the calculation (event data versus performance data) and the differing formulae themselves (f_p in the market calculation versus direct determination of EFDHs in computing transition rates). The small difference between the total UCAP determined by the NYISO Market EFORd formula and the GADS OS transition rate calculation demonstrates that the methodology for populating generator transition rate matrices for MARS that are consistent with the EFORd reliability index has been successfully implemented.

References

1. [IEEE Committee, "A four state model for estimation of outage risk for units in peaking service", IEEE Task Group on Model for Peaking Units of the Application of Probability Methods Subcommittee, IEEE Transactions, PAS-91 \(1972\), pp. 618-27.](#)
2. [North American Electric Reliability Corporation, "Generating Availability Data System: Data Reporting Instructions", North American Electric Reliability Corporation \(NERC\), January 2013.](#)
3. [Installed Capacity Subcommittee, "New York control Area Installed Capacity Requirements for the period May 2013 to April 2014: Appendix E—Development of Generator Transition Rate Matrices for MARS That Are consistent with the EFORD Reliability Index", New York State Reliability Council, LLC, Technical Report, December 7, 2012.](#)
4. [A.D. Patton, C. Singh, M. Sahinoglu, "Operating Considerations in Generation Reliability Modeling - An Analytical Approach", IEEE Transactions, PAS-100, May 1981.](#)
5. [A.D. Patton, C. Singh, et al, "Modeling of Unit Operating Considerations in Generating Capacity Reliability Evaluation", Vol. 1: Mathematical Models, Computing Methods, and Results, Electric Power Research Institute Report EPRI EL-2519, Vol. 1, Project 1534-1, July 1982.](#)
6. [C. Singh, "Reliability Calculations of Large Systems", Proceedings 1975 Reliability and Maintainability Symposium, 1975.](#)
7. [C. Singh & R. Billinton, "Frequency and Duration Concepts in System Reliability Evaluation", IEEE Transactions on Reliability, Vol. R-24, Bo 1, April 1975.](#)
8. [A.D. Patton, C. Singh, et al, "Reliability Modeling of Interconnected Systems Recognizing Operating Considerations", EPRI Report EL-4603, Vol. 1, Project RP 1534-2, Dec. 1985.](#)
9. [IEEE Std 762, "IEEE Standard Definitions for Use in Reporting Electric Generating Unit Reliability, Availability, and Productivity", 2008](#)
10. [M. P. Bhavaraju, J.A. Hynds, G.A. Nunan, "A method for estimating equivalent forced outage rates of multistate peaking units", IEEE Transactions on Power Apparatus and Systems, Vol. PAS-97, No. 6, Nov/Dec 1978](#)
11. [C. Singh, Course Notes: Electrical Power System Reliability, Available on URL: <http://www.ee.tamu.edu/People/bios/singh/index.htm>](#)
12. [New York Independent System Operator \(NYISO\), "Status of EFORD Methodology Review", New York State Reliability Council \(NYSRC\) Installed Capacity Subcommittee \(ICS\) white paper, NYSRC ICS Meeting #149, June 2013.](#)